



# **POWER SUPPLY COLLECTION**

## New Releases

Toughpower PF1 Platinum (High-Wattage) -----	05
Toughpower SFX Gold -----	07
Toughpower GF1 Snow Gold -----	09
Toughpower iRGB PLUS 1250W/1650W Titanium -----	11

## Analog Power Supply

Toughpower TF1 Titanium -----	15
Toughpower PF1 ARGB Platinum -----	19
Toughpower PF1 Platinum -----	23
Toughpower GF1 Gold (High-Wattage) -----	25
Toughpower GF2 ARGB Gold -----	27
Toughpower GF1 ARGB Gold -----	31
Toughpower GF1 Gold -----	35
Toughpower GX1 RGB Gold -----	37
Toughpower GX1 Gold -----	39

## Digital Power Supply

Toughpower iRGB PLUS Titanium -----	47
Toughpower iRGB PLUS Platinum -----	49
Toughpower iRGB PLUS Gold -----	51

## More Information

• >16ms and up Hold Up Time -----	57
• <30mV Low Ripple Noise -----	57
• Extremely Strict Voltage Regulation <math>\pm 2\%</math> -----	58
• 100% Japanese Capacitors -----	58
• High Amperage Single +12V Rail -----	59
• Smart Zero Fan -----	59
• DC to DC for Stable Output Voltage -----	60
• Fully Modular Cable Design -----	60
• 80 PLUS Titanium Certified -----	61
• 80 PLUS Platinum Certified -----	61
• 80 PLUS Gold Certified -----	62
• 80 PLUS BRONZE CERTIFIED AND INTEL C6/C7 STATES READY -----	62
• CYBENETICS EFFICIENCY LEVELS (115V/230V) -----	63
• CYBENETICS NOISE LEVELS (115V/230V) -----	64

# New Releases



Toughpower PF1  
1050W / 1200W



Toughpower SFX  
750W / 850W



Toughpower GF1 Snow  
650W / 750W / 850W



Toughpower iRGB PLUS  
1250W / 1650W





## Toughpower PF1 Platinum

### 1200W/1050W

The Toughpower PF1 Platinum 1200W/1050W comes in a high wattage model of 1200/1050 watts and delivers 80 PLUS Platinum efficiency. Besides its fundamental features like low ripple noise and strict voltage regulation, the Toughpower PF1 Platinum 1200W/1050W has two other critical characteristics – its compact size and an upgraded cooling fan. With its small footprint of 150mm (W) x 86mm (H) x 140mm (D), the PF1 Platinum 1200W/1050W provides ample space for cable management. Compared to the PF1 Platinum 850W/750W/650W, the PF1 Platinum 1200W/1050W comes with a low vibration designed 120mm High Static Pressure Fan, providing better cooling performance while maintaining silence operation.

### Features

- New Board Technology Offering Single Side SMD
- Compact Design 140mm (L) x 150mm (W) x 86mm (H)
- DC to DC Circuit Design
- 120mm High Static Pressure Fan



• Smart Zero Fan



• < 30mv Low Ripple Noise



• > 16 ms Hold Up Time at 100% workload



• < ± 2% Strict Voltage Regulation



• 100% Japanese Capacitors (105°C/221°F Ambient)



• Complete Hardware Protection (OCP, OVP, UVP, OPP, SCP, OTP)



## 120mm High Static Pressure Fan

Up to 2500 RPM fan speed, the preinstalled High Static Pressure Fan provides an outstanding cooling performance while maintains a silent operation.

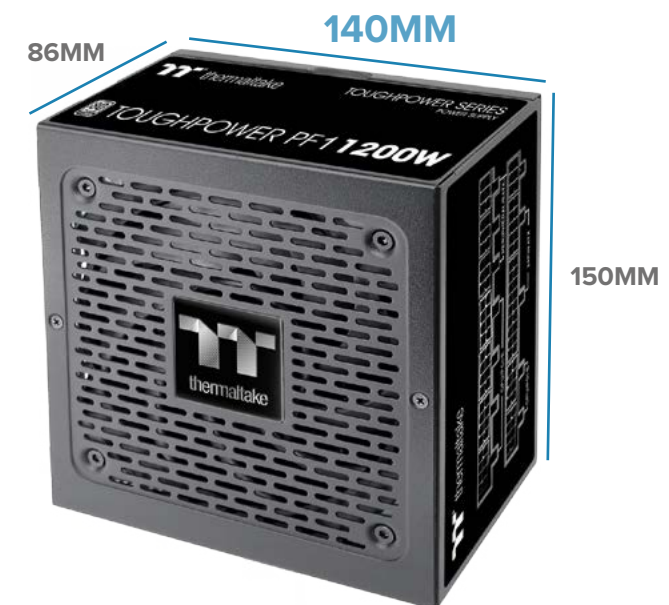

## Compact Design with 140mm Depth

The Toughpower PF1 Platinum Series is designed to be compact with size of 140mm (D) x 86mm (H) x 150mm (L) which provides ample space for cable management.







## Toughpower SFX Gold

850W/750W/650W/550W/450W

The fully modular Toughpower SFX Gold Series is now available in high-wattages of 850W/750W, making this Thermaltake small form factor power supply series even more complete. The Toughpower SFX 850W/750W/650W/550W/450W is built to deliver 80 PLUS Gold efficiency. Upgraded from previous Toughpower SFX 450W/600W Gold, the latest Toughpower SFX Gold series not only covers more wattages but contains more critical features which include <30mv Low Ripple Noise and  $\pm 2\%$  Strict Voltage Regulation.

## Features

- 
• < 30mv Low Ripple Noise
- 
• <  $\pm 2\%$  Strict Voltage Regulation
- 
• Smart Zero Fan
- 
• 100% Japanese Capacitors (105°C / 221 °F Ambient)
- 
• Complete hardware protection: OCP, OVP, UVP, OPP, SCP, OTP
- DC to DC circuit design



# Toughpower SFX Gold

850W/750W/650W/550W/450W



## Toughpower GF1 Snow Gold

850W/750W/650W

The fully modular Toughpower GF1 series is now available in snow edition which comes with 650W/750W/850W models and built to deliver 80 PLUS Gold efficiency. The series features a 140mm hydraulic bearing fan, Japanese capacitors and other premium components to help deliver a continuous and stable power with an ambient temperature up to 50°C, while near silent operation and reliable performance are guaranteed. With an ample 10-year warranty, the Toughpower GF1 Snow Gold Series is able to satisfy the market, where PC enthusiasts are looking for a premium power supply with all the latest features.

### Features



- Smart Zero Fan



- < 30mV Low Ripple Noise



- > 16 ms Hold Up Time at 100% workload



- < ±2% Strict Voltage Regulation



- 100% Japanese Capacitors (105°C / 221 °F Ambient)



- Complete Hardware Protection (OCP, OVP, UVP, OPP, SCP, OTP)

- DC to DC Circuit Design



## Ultra Quiet 140mm Hydraulic Bearing Fan

Featuring a 140mm hydraulic bearing fan with intelligent RPM controls to help guarantee superior cooling performance and near silent operation.





## Toughpower iRGB PLUS Titanium 1250W/1650W

Builds up with great quality and patented ultra-silent, 16.8 million-color Riing Duo RGB fan and 18 controllable single LEDs with 8 lighting modes, plus the support for three of intelligent platforms to help users monitor smart power supply units, and also becomes the world's first voice controllable digital power supply which can also be sync with all other Thermaltake TT RGB PLUS sync compatible products.

## Features

- Transient Response 12V < 1% , 5V< 3%, 3.3V < 5%, %, 5VSB<1%
- Inrush current < 50 Ampere
- Standby < 0.1W power consumption



- Digitally controlled Riing Duo RGB 16.8 million colors PSU fan features 18 addressable LEDs with 8 lighting modes



- World's first voice controllable RGB fan



- TT RGB PLUS Sync Compatible



- Smart Power Management integration for PSU/PC status monitoring and timely warning alert



- Amazon Alexa Supported



- Strict voltage regulation provides stable voltage



- 100% Japanese Capacitors (105°C /221 °F Ambient)



- Complete Hardware Protection (OCP, OVP, UVP, OPP, SCP, OTP)



- < 30mV Low Ripple Noise



- > 16 ms Hold Up Time at 100% workload



- < ±2% Strict Voltage Regulation

# Analog Power Supply

Thermaltake constructs Analog PSUs with premium components and tight regulations, and impresses the market as being the pioneer in the industry that incorporates RGB lights into analog PSUs. It is the best choice for those who are seeking a flashy looking PSU with excellent balance of performance and quality.

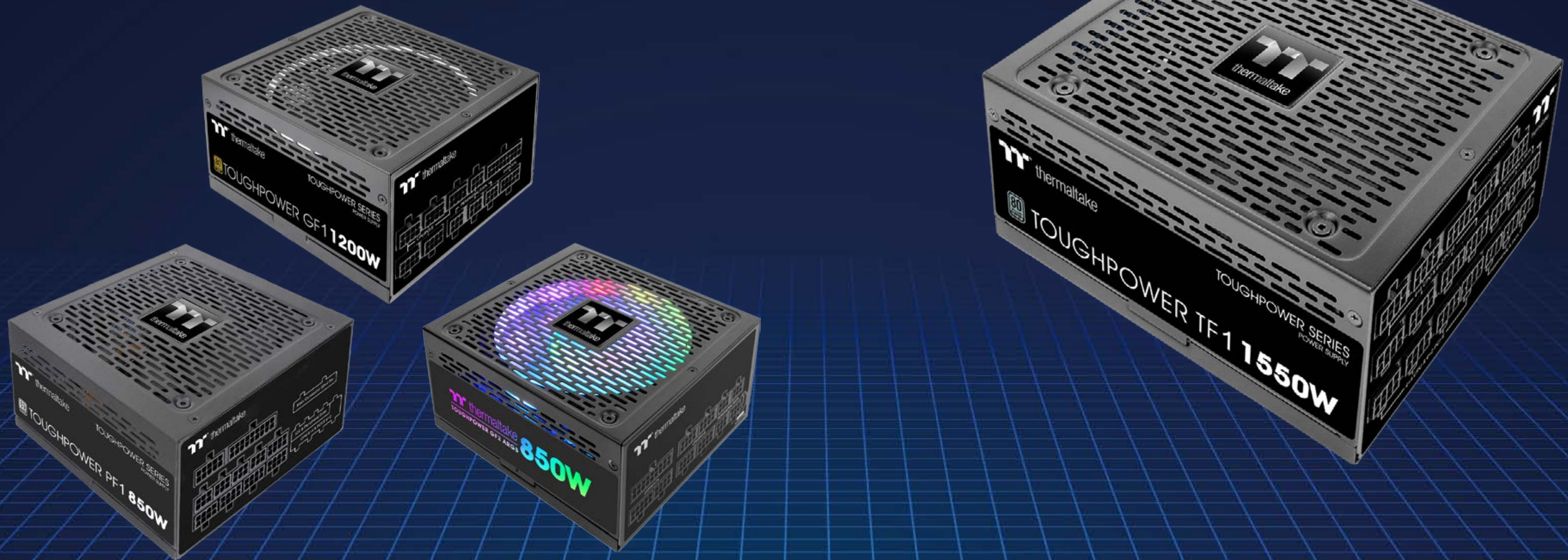









## Toughpower TF1 1550W Titanium

The Toughpower TF1 1550W Titanium is our first ever analog power supply that delivers 80 PLUS Titanium efficiency. It's not only designed to fill up Thermaltake PSU product composition but to give you an ideal option for overclocking. This power supply contains critical features such as Transient Response  $12V < 1\%$ ,  $5V < 3\%$ ,  $3.3V < 5\%$ ,  $5VSB < 1\%$ , Inrush current  $< 50$  Ampere and 12V SATA OCP Protection to protect your hard drives.

### Features

- Transient Response  $12V < 1\%$ ,  $5V < 3\%$ ,  $3.3V < 5\%$ ,  $5VSB < 1\%$
- Inrush current  $< 50$  Ampere
- 12V SATA OCP Protection for protecting hard drives
- Turbo Fan button
- Extra jumper accessory
-   $< 30\text{mv}$  Low Ripple Noise
-   $> 16$  ms Hold Up Time at 100% workload
-   $< \pm 2\%$  Strict Voltage Regulation
-  80 PLUS Titanium Certified
-  100% High quality  $105^\circ\text{C}$  Japanese capacitors
-  Complete hardware protection: OCP, OVP, UVP, OPP, SCP, OTP

### Transient Response

$12V < 1\%$ ,  $5V < 3\%$ ,  $3.3V < 5\%$ ,  $5VSB < 1\%$

A measure of how well the power source can hold its output constant in response to load changes. We make sure that we can keep the results compliant with  $12V < 1\%$ ,  $5V < 3\%$ , and  $3.3V < 5\%$  to avoid PSU output voltage deviation causing subsequent equipment malfunction or even shut down.

### Inrush Current $< 50$ Ampere

Inrush current is the instantaneous high input current drawn by a power supply or electrical equipment at turn-on. This arises due to the high initial currents required to charge the capacitors and inductors or transformers. We make sure that test results are under 50 ampere to avoid damage to the PSU components.

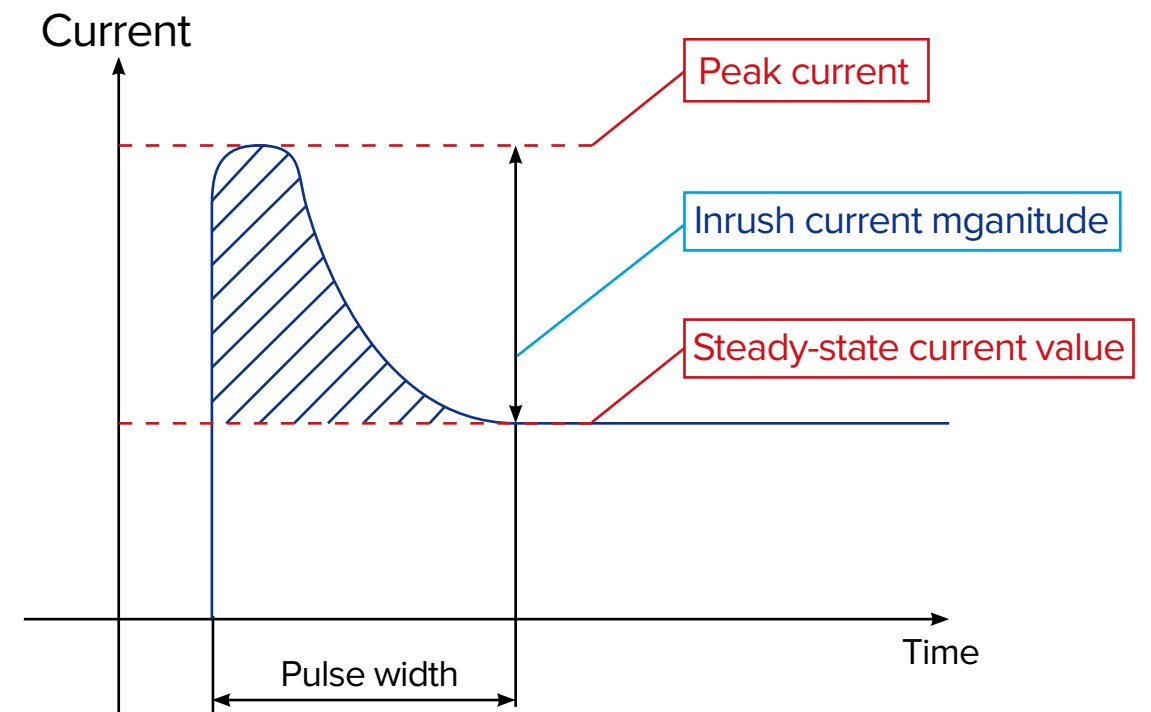

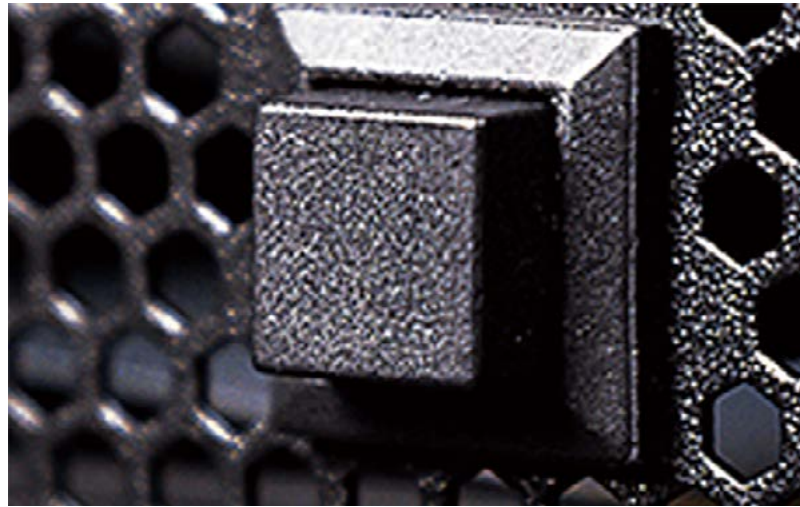

## Turbo Fan Button

The turbo fan button can supply on-demand increased airflow when maximum performance is needed.



## Extra Jumper Accessory

We provide a jumper for the user's PSU in order to provide electricity to the graphics card without connecting to the motherboard.



# Toughpower TF1 1550W Titanium











## Toughpower PF1 ARGB Platinum

1200W/1050W/850W

The Toughpower PF1 ARGB Platinum Series comes preinstalled with a patented ultra-silent 16.8 million-color ARGB Riing Duo fan which includes 18 LEDs that can be controlled by 7 light modes. Users can easily adjust the lighting on the PSU to their preferred color scheme. The PF1 ARGB Platinum Series is designed with Ultra-low ripples and strict voltage regulations, designed and tested to insure unrivaled stability and performance throughout.

### Features

-  • 16.8million-color, 18 LEDs Riing Duo RGB Fan with 7 lighting modes
-  • RGB Lighting in Sync with Asus/Gigabyte/MSI Motherboards with +5V RGB Header
-  • RGB side panels
-  • Smart Zero Fan
-  • < 30mv Low Ripple Noise
-  • > 16 ms Hold Up Time at 100% workload
-  • < ±2% Strict Voltage Regulation
-  • 100% Japanese Capacitors (105°C /221 °F Ambient)
-  • Complete Hardware Protection (OCP, OVP, UVP, OPP, SCP, OTP)
- DC to DC Circuit Design

## RGB Lighting in Sync with Asus/Gigabyte/MSI Motherboards

Thermaltake has teamed up with enthusiasts' favorite motherboard brands, Asus/Gigabyte/MSI, to give even more illumination synchronization options. Just connect the power supply to the Asus AURA SYNC/Gigabyte RGB Fusion/MSI Mystic Light Sync-enabled motherboards for the ultimate compatibility without the need to install any other lighting controllers or software.



## Patented 16.8 Million Colors Riing Duo 14 RGB Fan

One PSU, infinite possibilities! All starts from 18 addressable LEDs giving wide light, color and brightness coverage, and 2 LED rings bringing 16.8million-color illumination.

## Structure

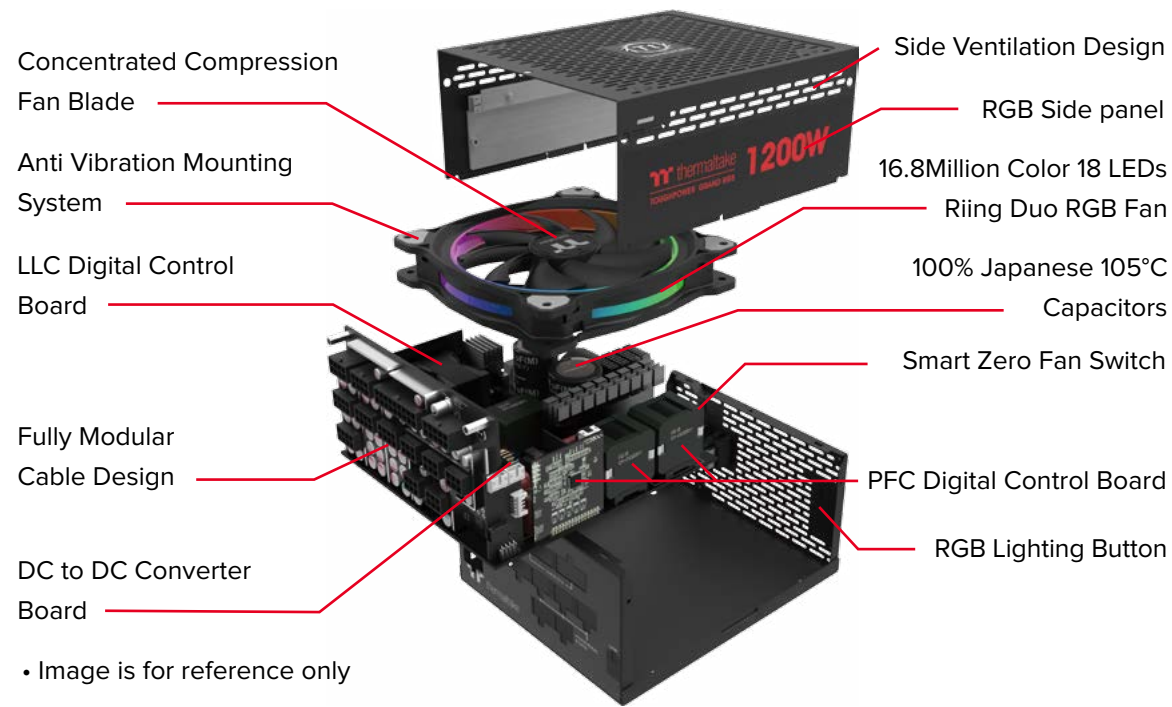

# Toughpower PF1 ARGB Gold

1200W/1050W/850W



## Toughpower PF1 Platinum

### 850W/750W/650W

The Toughpower PF1 Platinum Series comes in 850W/750W/650W and delivers 80 PLUS Platinum efficiency. Besides the fundamental features listed below, The PF1 Platinum Series has two other critical characteristics – compact size and our new board technology. With the small footprint of 150mm (W) x 86mm (H) x 140mm (D), the PF1 prides its ample space for cable management. The new board technology offers single sided SMD which all IC chips are set to only one side, allowing the heat to only be accumulated on one side so the entire board can be covered and cooled down by the 120mm ultra quiet Hydraulic Bearing Fan.

## Features

- New Board Technology Offering Single Side SMD
- Compact Design 140mm (L) x 150mm (W) x 86mm (H)
- DC to DC Circuit Design



• Smart Zero Fan



• < 30mv Low Ripple Noise



• > 16 ms Hold Up Time at 100% workload



• < ± 2% Strict Voltage Regulation



• 100% Japanese Capacitors (105°C/221°F Ambient)



• Complete Hardware Protection (OCP, OVP, UVP, OPP, SCP, OTP)



## New Board Technology Offering Single Sided SMD

The new board design allows all SMD sit on the top side of the PSU PC board. This design not only can create less heat accumulate in the bottom of PSU but also help minimize power loss and increase efficiency.



## Compact Design with 140mm Depth

The Toughpower PF1 Platinum Series is designed to be compact with size of 140mm (D) x 86mm (H) x 150mm (L) which provides ample space for cable management.

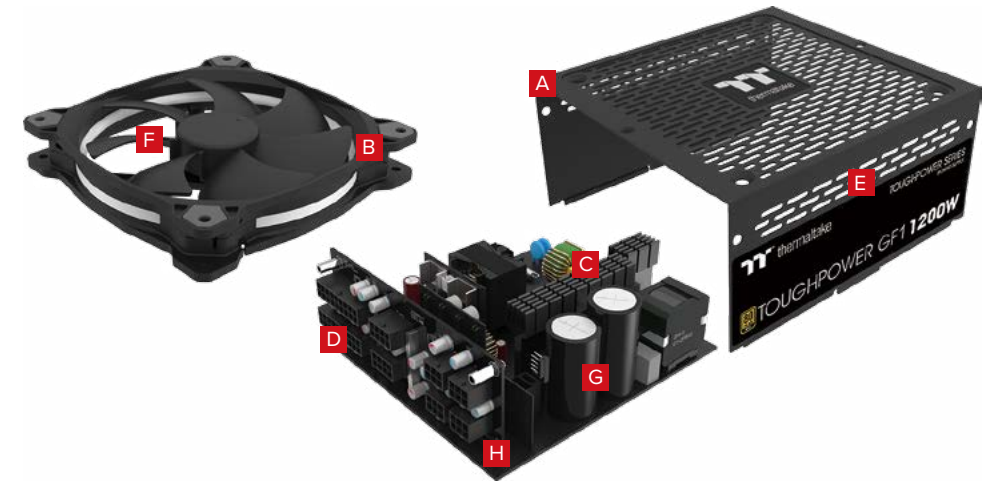







## Toughpower GF1 Gold

1200W/1000W

In order to fulfill the demand of high-end graphics cards on the market, we've decided to level up one of our top selling PSUs – the Toughpower GF1 Gold Series. It is now available in 1200W/1000W models and is built to deliver 80 PLUS Gold efficiency. The series features a 140mm hydraulic bearing fan, Japanese capacitors and other premium components to help deliver continuous and stable power with an ambient temperature of up to 50°C, whilst keeping near silent operation and reliable performance is guaranteed. With an ample 10-year warranty, the Toughpower GF1 is able to satisfy the market, where PC enthusiasts are looking for a premium power supply with all the latest features.

### Features

-  • Smart Zero Fan
-  • < 30mV Low Ripple Noise
-  • > 16 ms Hold Up Time at 100% workload
-  • < ±2% Strict Voltage Regulation
-  • 100% Japanese Capacitors (105°C /221 °F Ambient)
-  • Complete Hardware Protection (OCP, OVP, UVP, OPP, SCP, OTP)
- DC to DC Circuit Design

- A.** Durable Chassis
- B.** Anti-Vibration Mounting System
- C.** DC to DC Design
- D.** Modular Cable Management
- E.** Side Ventilation Design
- F.** Concentrated Compression Fan Blade
- G.** 100% High Quality Japanese 105°C / 221°F Capacitors
- H.** Zero Cable Platform



## Ultra Quiet 140mm Hydraulic Bearing Fan

Featuring a 140mm hydraulic bearing fan with intelligent RPM controls to help guarantee superior cooling performance and near silent operation.











## Toughpower GF2 ARGB Gold

850W/750W/650W

The Toughpower GF2 ARGB Gold Series comes with a preinstalled patented ultra-silent 16.8 million-color ARGB Riing Duo fan which includes 18 LEDs that can be controlled by the motherboard RGB software from ASUS Aura Sync, GIGABYTE RGB Fusion, MSI Mystic Light Sync and ASRock Polychrome. Otherwise you can change the RGB physically with the color buttons on the back of the power supply.

### Features

-  • 16.8 million colors ARGB Riing Duo Fan
-  • RGB Sync with Asus Aura, Gigabyte RGB Fusion, MSI Mystic Light, +5V
-  • RGB Side Panels
-  • Smart Zero Fan
-  • < 30mv Low Ripple Noise
-  • > 16 ms Hold Up Time at 100% workload
-  • < ±2% Strict Voltage Regulation
-  • 100% Japanese Capacitors (105°C /221 °F Ambient)
-  • Complete Hardware Protection (OCP, OVP, UVP, OPP, SCP, OTP)
- DC to DC Circuit Design

### 18 Addressable RGB LEDs

Users can easily configure their RGB lighting with RGB motherboards.

### RGB Side Panels

Comes with RGB side panels to ensure the ultimate RGB lighting visibility no matter how users want to place the power supply.



### Lighting effect options

7 color options



8 Light modes

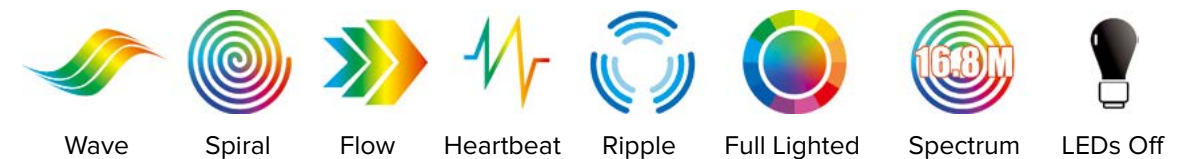



## RGB Sync

All motherboards that come with +5V RGB header provided by ASUS AURA, GIGABYTE RGB FUSION, MSI MYSTIC LIGHT, are compatible with the RGB sync function. RGB color mode and color switches are also provided for those who do not have a RGB header available.

(+12V RGB header is not supported)



## Fully Modular Flat Cables



# Toughpower GF2 ARGB Gold

850W/750W/650W











## Toughpower GF1 ARGB Gold

850W/750W/650W

The Toughpower GF1 ARGB Gold Series comes preinstalled with a patented ultra-silent 16.8 million-color ARGB Riing Duo fan which includes 18 LEDs that can be controlled by 7 light modes. Users can easily adjust the lighting on the PSU to their preferred color scheme. The GF1 ARGB Gold Series is designed with Ultra-low ripples and strict voltage regulations, designed and tested to insure unrivaled stability and performance throughout.

### Features

-  • 16.8million-color, 18 LEDs Riing Duo RGB Fan with 7 lighting modes
-  • RGB Lighting in Sync with Asus/Gigabyte/MSI/ASRock/BioStar Motherboards with +12V RGB Header
-  • Smart Zero Fan
-  • < 30mV Low Ripple Noise
-  • > 16 ms Hold Up Time at 100% workload
-  • < ±2% Strict Voltage Regulation
-  • 100% Japanese Capacitors (105°C /221 °F Ambient)
-  • Complete Hardware Protection (OCP, OVP, UVP, OPP, SCP, OTP)
- DC to DC Circuit Design

## RGB Lighting in Sync with Asus/Gigabyte/MSI/ASRock/BioStar Motherboards

Thermaltake has teamed up with enthusiasts' favorite motherboard brands, Asus/Gigabyte/MSI/ASRock/BioStar, to give even more illumination synchronization options. Just connect the power supply to the Asus AURA SYNC/Gigabyte RGB Fusion/MSI Mystic Light Sync/ASRock RGB LED/ BioStar VIVID LED DJ -enabled motherboards for the ultimate compatibility without the need to install any other lighting controllers or software.



## Patented 16.8 Million Colors Riing Duo 14 RGB Fan

One PSU, infinite possibilities! All starts from 18 addressable LEDs giving wide light, color and brightness coverage, and 2 LED rings bringing 16.8million-color illumination.

## Structure

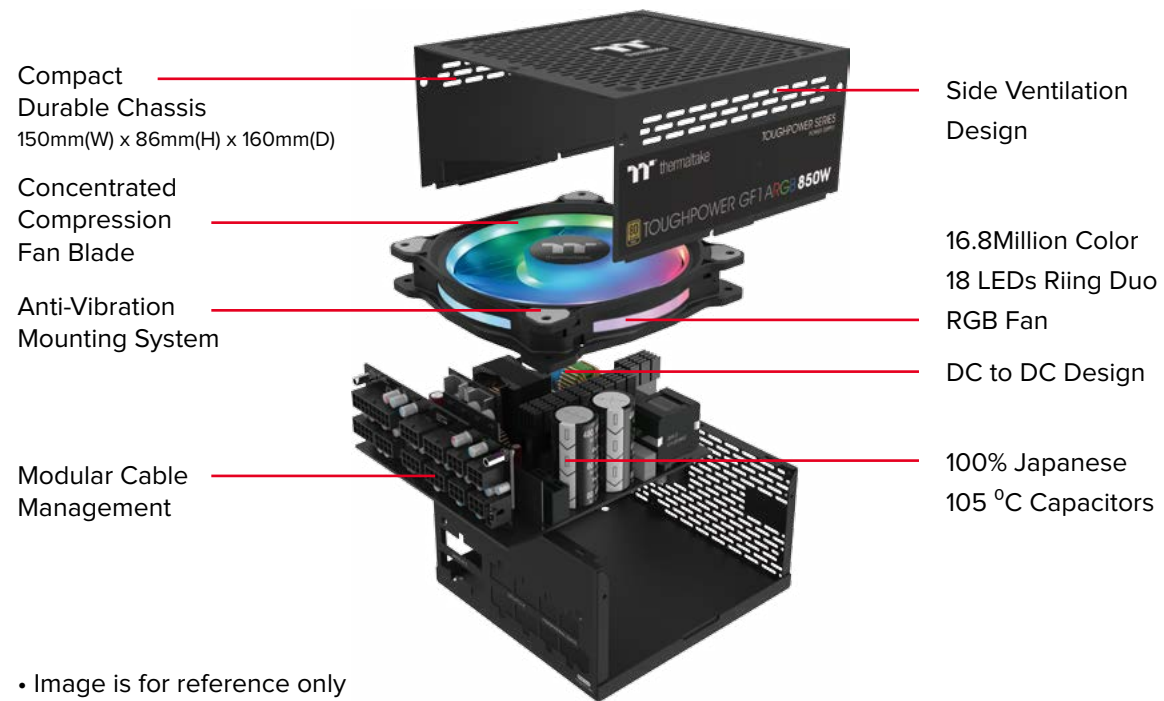

# Toughpower GF1 ARGB Gold

850W/750W/650W

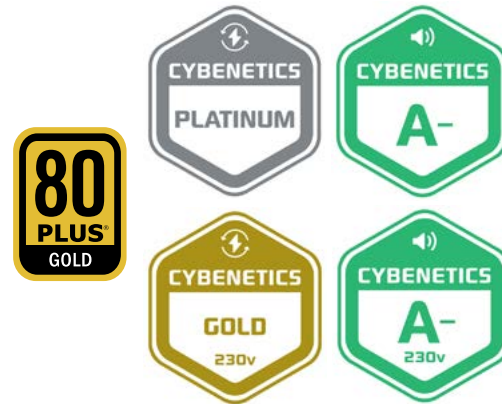







## Toughpower GF1 Gold

850W/750W/650W

The fully modular Toughpower GF1 series is available in 650W - 850W models and built to deliver 80 PLUS Gold efficiency. The series features a 140mm hydraulic bearing fan, Japanese capacitors and other premium components to help deliver a continuous and stable power with an ambient temperature up to 50°C, while near silent operation and reliable performance are guaranteed. With an ample 10-year warranty, the Toughpower GF1 is able to satisfy the market, where PC enthusiasts are looking for a premium power supply with all the latest features.

### Features

-  • Smart Zero Fan
-  • < 30mV Low Ripple Noise
-  • > 16 ms Hold Up Time at 100% workload
-  • < ±2% Strict Voltage Regulation
-  • 100% Japanese Capacitors (105°C / 221 °F Ambient)
-  • Complete Hardware Protection (OCP, OVP, UVP, OPP, SCP, OTP)
- DC to DC Circuit Design

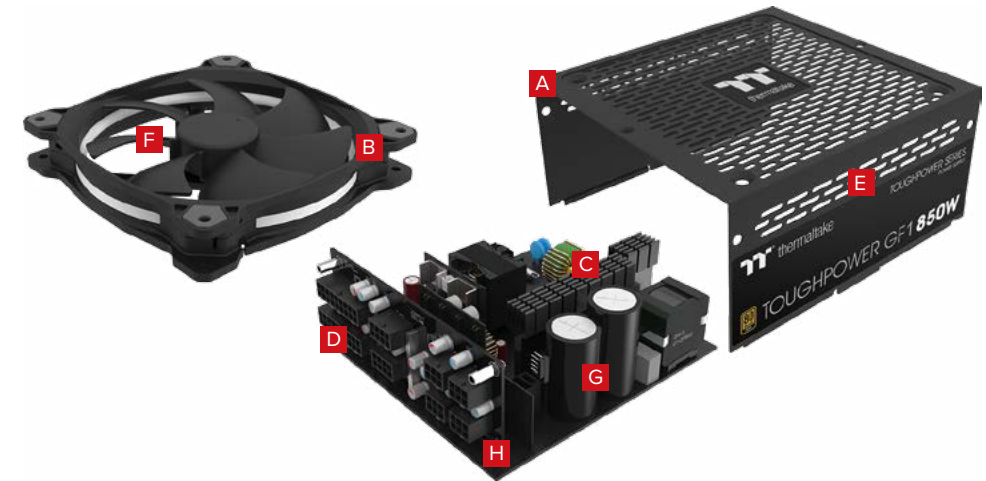

- A.** Durable Chassis
- B.** Anti-Vibration Mounting System
- C.** DC to DC Design
- D.** Modular Cable Management
- E.** Side Ventilation Design
- F.** Concentrated Compression Fan Blade
- G.** 100% High Quality Japanese 105°C / 221°F Capacitors
- H.** Zero Cable Platform



## Ultra Quiet 140mm Hydraulic Bearing Fan

Featuring a 140mm hydraulic bearing fan with intelligent RPM controls to help guarantee superior cooling performance and near silent operation.



## Toughpower GX1 RGB Gold

700W/600W/500W

Built to deliver 80 PLUS Gold efficiency, Toughpower GX1 RGB comes with capacities ranging from 500W to 700W, and the application of 10 LEDs for illuminating 256 Colors RGB Cycle, 120mm Hydraulic Bearing Fan, <math>\pm 3\%</math> tight voltage regulation, Japanese 105°C/221°F main capacitor and premium components. Its near silent operation, trouble free installation and reliable performance are making itself one of the best values for basic system upgrades.

### Features



• 15 colors Effects including 256 colors RGB Cycle



• 10 LEDs with control Button



• 120mm RGB Hydraulic Bearing Fan



• <math>< 60\text{mV}</math> Low Ripple Noise



• <math>< \pm 3\%</math> Strict Voltage Regulation



• Japanese Main Capacitor (105°C / 221 °F Ambient)



• Complete Hardware Protection (OCP, OVP, UVP, OPP, SCP, OTP)

## One Button to Your Desired Color

By pressing RGB lighting button, the fan color can be switched between amount a 256 Color RGB cycle with variants including Red, Green, Blue, Yellow, Purple, Light Blue, White, and an LED Off mode. The fan is also constructed with a built – in memory function, saving the color applied and insuring the same color selection every time you boot your PC.



“RGB Cycle”

## 120mm RGB Hydraulic Bearing Fan

Hydraulic Bearing Fan comes with long lifespan -- ranging anywhere from 100,000 hours on the low end (40-70C) to upwards of 300,000 hours. They are generally preferential for sustainability and relative silence, while pushing the same or more air as other fans of their range.

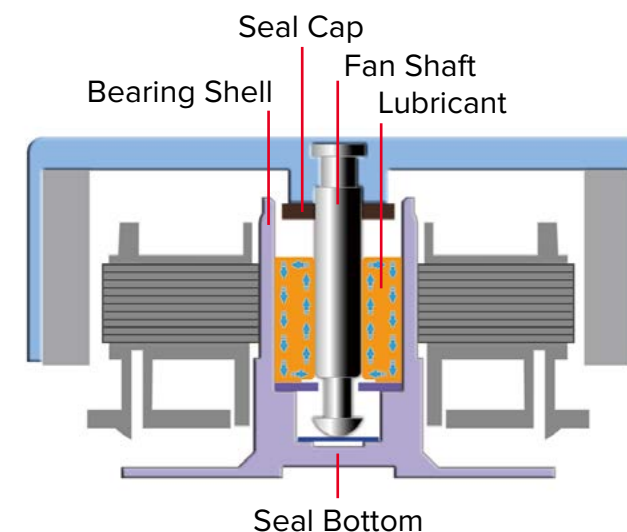



## Toughpower GX1 Gold

700W/600W/500W

Built to deliver 80 PLUS Gold efficiency, Toughpower GX1 comes with capacities ranging from 500W to 700W, and the application of 120mm Fluid Dynamic Bearing Fan,  $\pm 3\%$  tight voltage regulation, Japanese  $105^{\circ}\text{C}/221^{\circ}\text{F}$  main capacitor and premium components. Its near silent operation, trouble free installation and reliable performance are making itself one of the best values for basic system upgrades.

### Features



• 120mm Fluid Dynamic Bearing Fan (FDB)



•  $< 60\text{mV}$  Low Ripple Noise



•  $< \pm 3\%$  Strict Voltage Regulation



• Japanese Main Capacitor ( $105^{\circ}\text{C} / 221^{\circ}\text{F}$  Ambient)



• Complete Hardware Protection (OCP, OVP, UVP, OPP, SCP, OTP)

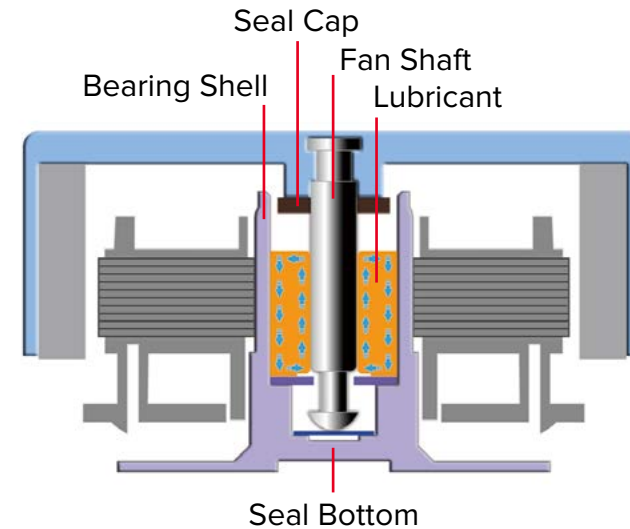

## 120mm Fluid Dynamic Bearing Fan

Fluid-dynamic fan bearings have the greatest lifespan -- ranging anywhere from 100,000 hours on the low end ( $40\text{-}70^{\circ}\text{C}$ ) to upwards of 300,000 hours. They are generally preferential for sustainability and relative silence, while pushing the same or more air as other fans of their range.





## Japanese Brand Main Capacitor

High quality  $105^{\circ}\text{C}$  ( $221^{\circ}\text{F}$ ) Japanese brand main capacitor greatly improves the durability and offers the highest stability and reliability

• Image is for reference only

															
Product Name	Toughpower PF1 Platinum	Toughpower SFX Gold Series <b>New New</b>			Toughpower GF1 Snow Gold Series	Toughpower TF1 Titanium Series	Toughpower GF1 Gold Series			Toughpower GF2 ARGB (RGB Side Panels) Gold Series	Toughpower PF1 (RGB Side Panels) ARGB Platinum Series	Toughpower GF1 ARGB Gold Series	Toughpower PF1 Platinum Series	Toughpower GX1 RGB Gold Series	Toughpower GX1 Gold Series
Wattage Range	1200W 1050W	850W 750W 650W 550W 450W	850W 750W 650W	1550W	1200W 1000W 850W 750W 650W	850W 750W 650W	1200W 1050W 850W	850W 750W 650W	850W 750W 650W	850W 750W 650W	700W 600W 500W	700W 600W 500W			
80 +	Platinum	Gold	Gold	Titanium	Gold	Gold	Platinum	Gold	Platinum	Gold	Gold	Gold			
Cabling	Fully Modular	Fully Modular	Fully Modular	Fully Modular	Fully Modular	Fully Modular	Fully Modular	Fully Modular	Fully Modular	Fully Modular	Non Modular	Non Modular			
Input Voltage	100V ~ 240V	Full Range	Full Range	Full Range	Full Range	Full Range	Full Range	Full Range	Full Range	Full Range	Full Range	Full Range			
RGB Lighting	N/A	N/A	N/A	N/A	N/A	16.8 million colors RGB Control Switch	16.8 million colors RGB Control Switch	16.8 million colors RGB Control Switch	N/A	256 Colors RGB Control Switch	N/A				
LED Light Bulbs	N/A	N/A	N/A	N/A	N/A	42	42	18	N/A	10	N/A				
Fan	120 mm high static pressure Fan	90mm Hydraulic Bearing Fan	140mm Hydraulic Bearing Fan	140mm Fluid Dynamic Fan	140mm Hydraulic Bearing Fan	Patented 16.8 million colors Riing Duo ARGB Hydraulic Bearing fan	Patented 16.8 million colors RGB Hydraulic Bearing fan	Patented 16.8 million colors RGB Hydraulic Bearing fan	120mm Hydraulic Bearing Fan	120mm RGB Hydraulic Bearing Fan	120mm RGB Hydraulic Bearing Fan				
Smart Zero Fan	Yes	No	Yes	No	Yes	Yes	Yes	Yes	Yes	No	No				
Operating Temperature	5° C ~ 50° C	0° C ~ 50° C	0° C ~ 50° C	0° C ~ 50° C	0° C ~ 50° C	0° C ~ 50° C	0° C ~ 50° C	0° C ~ 50° C	0° C ~ 50° C	0° C ~ 40° C	0° C ~ 40° C				
Ripple Noise Design	Less Than 30 mV for Major Rails	Less Than 30 mV for Major Rails	Less Than 30 mV for Major Rails	Less Than 30 mV for Major Rails	Less Than 30 mV for Major Rails	Less Than 30 mV for Major Rails	Less Than 30 mV for Major Rails	Less Than 30 mV for Major Rails	Less Than 30 mV for Major Rails	Less Than 60 mV for Major Rails	Less Than 60 mV for Major Rails				
Voltage Regulation	±2% for Major Rails	±2% for Major Rails	±2% for Major Rails	±2% for Major Rails	±2% for Major Rails	±2% for Major Rails	±2% for Major Rails	±2% for Major Rails	±2% for Major Rails	±3% for Major Rails	±3% for Major Rails				
Capacitor	100% high quality Japanese capacitors	Japanese 105°C	Japanese 105°C	Japanese 105°C	Japanese 105°C	Japanese 105°C	Japanese 105°C	Japanese 105°C	Japanese 105°C	Japanese 105°C Main	Japanese 105°C Main				
Warranty	10 Years	10 Years	10 Years	10 Years	10 Years	10 Years	10 Years	10 Years	10 Years	5 Years	5 Years				
Main Power Connector (20+4)	1	1	1	1	1	1	1	1	1	1	1				
CPU (8Pin)	N/A	N/A	1 - -	1	1 - -	N/A	1	N/A	N/A	N/A	N/A				
CPU (4+4Pin)	2	1	1 2 2	1	1 1 1 2 2	1	1	1	1	1	1				
SATA (5Pin)	12 12	3	12 9 9	16	12 12 12 9 9	12 9 9	12 12 12	12 9 9	12 9 9	12 9 9	8 8 6	8 8 6			
PCI-E (6+2)	8 8	2	6 4 4	12	8 8 6 4 4	6 4 4	8 8 6	6 4 4	6 4 4	6 4 4	4 2 2	4 2 2			
Periphral (4Pin)	8 4	2	4 4 4	8	4 4 4 4 4	4 4 4	8 4 4	4 4 4	4 4 4	4 4 4	4 4 4	4 4 4			
Floppy (4Pin)	1 1	1	1 1 1	1	1 1 1 1 1	1 1 1	1 1 1	1 1 1	1 1 1	1 1 1	1 1 1	1 1 1			

																																						
Toughpower Grand RGB Gold (RGB Sync Edition Series)			Smart Pro RGB Bronze Series			Smart BX1 RGB 230V & Full Range Series			Smart BX1 230V & Full Range Series			Smart RGB 230V Series			Smart RGB Series			Smart RGB Series (230V)			Litepower RGB (230V)			Smart SE 87%			SMART BM2			Smart BM1								
850W	750W	650W	850W	750W	650W	750W	650W	550W	750W	650W	550W	450W	700W	600W	500W	700W	600W	500W	700W	600W	500W	650W (Peak Wattage)	550W (Peak Wattage)	450W (Peak Wattage)	730W	630W	530W	750W	650W	550W	450W	700W	600W	500W				
Gold			Bronze			Bronze			Bronze			230V Standard			Standard			Standard			Non 80+			Non 80+			Bronze			Bronze								
Fully Modular			Fully Modular			Non Modular			Non Modular			Non Modular			Non Modular			Non Modular			Non Modular			Non Modular			Semi Modular			Semi Modular			Semi Modular					
Full Range			Full Range			230			Full Range & 230V			230V			Full Range			230V			230V			230V			230V			Full Range			230V					
256 Colors RGB Control Switch			256 Colors RGB Control Switch			256 Colors RGB Control Button			N/A			256 Colors RGB Control Button			256 Colors RGB Control Button			256 Colors RGB Control Button			256 Colors RGB Control Button			256 Colors RGB Control Switch			N/A			N/A			N/A					
2			2			10			N/A			10			10			10			10			10			N/A			N/A			N/A					
Patented Riing 14 RGB Fluid Dynamic Bearing fan			Patented Riing 14 RGB Fluid Dynamic Bearing fan			120mm RGB Hydraulic Bearing Fan			120mm Hydraulic Bearing Fan			120mm RGB Hydraulic Bearing Fan Hub			120mm RGB Hydraulic Bearing Fan Hub			120mm RGB Hydraulic Bearing Fan Hub			120mm RGB Hydraulic Bearing Fan Hub			120mm RGB Hydraulic Bearing Fan Hub			140mm sleeve Fan			140mm FRifle-bearing Fan			140mm Hydraulic Bearing Fan					
Yes			Yes			No			No			No			No			No			No			No			No			No			No					
0° C ~ 50° C			0° C ~ 40° C			0° C ~ 40° C			0° C ~ 40° C			0° C ~ 40° C			0° C ~ 40° C			0° C ~ 40° C			0° C ~ 40° C			0° C ~ 35° C			0° C ~ 35° C			0° C ~ 40° C			0° C ~ 40° C					
Less Than 30 mV for Major Rails			Less Than 50 mV for Major Rails			Less Than 80 mV for Major Rails			Less Than 80 mV for Major Rails			Intel Requirement			Intel Requirement			Intel Requirement			Intel Requirement			Intel Requirement			Intel Requirement			Intel Requirement			12V Rail less than 80mV 3.3V & 5V Rail less than 40mV			Less Than 80 mV for Major Rails		
±2% for Major Rails			±3% for Major Rails			Intel Requirement			Intel Requirement			Intel Requirement			Intel Requirement			Intel Requirement			Intel Requirement			Intel Requirement			Intel Requirement			Intel Requirement			±5% for Major Rails			Intel Requirement		
Japanese 105°C			Japanese 105°C Main			Japanese Main			Japanese Main			Non Japanese			Non Japanese			Non Japanese			Non Japanese			Non Japanese			Non Japanese			Non Japanese			Japanese Main			Japanese Main		
10 Years			7 Years			5 Years			5 Years			5 Years			5 Years			5 Years			5 Years			5 Years			2 Years			3 Years			5 Years			5 Years		
1			1			1			1			1			1			1			1			1			1			1			1			1		
N/A			N/A			N/A			N/A			N/A			N/A			N/A			N/A			N/A			N/A			N/A			1			N/A		
1			1			1			1			1			1			1			1			1			1			1			1			1		
12	9	9	9	9	6	8	6	6	8	6	6	4	6	5	5	6	6	6	6	5	5	5	5	4	6	6	6	6	6	6	9	8	6	6				
6	4	4	4	4	4	4	2	2	4	2	2	2	2	2	2	2	2	2	2	2	2	2	2	2	4	2	2	2	2	4	4	4	4	2	2			
4	4	4	4	4	4	4	4	4	4	4	4	3	5	4	4	5	3	3	5	4	4	6	4	4	3	3	3	4	4	4	4	4	4	4	4			
1	1	1	1	1	1	1	1	1	1	1	1	1	1	1	1	1	1	1	1	1	1	1	1	1	1	1	1	1	1	1	1	1	1	1	1			

# Digital Power Supply

Thermaltake digital power supply series feature a 32bit Microcontroller unit containing a processor core, memory, and programmable input/output allowing the support for our intelligent SPM platform. This series is the world's first voice controllable series which users can access current status and other important key parameters.

Users can gain control over their lighting and speed and other real-time alerts such as PSU abnormalities. As a member of the TT RGB PLUS Ecosystem, you can now seamlessly sync all your products which are included the ecosystem.













## Toughpower iRGB PLUS Titanium Series 1250W

Builds up with great quality and patented ultra-silent, 16.8 million-color RGB fan and 12 controllable single LEDs with 8 lighting modes, plus the support for three of intelligent platforms to help users monitor smart power supply units, and also becomes the world's first voice controllable digital power supply which can also be sync with all other Thermaltake TT RGB PLUS sync compatible products.

## Features

- 
  - Digitally controlled Riing PLUS RGB 16.8 million colors PSU fan with 8 lighting modes
- 
  - World's first voice controllable RGB fan
- 
  - TT RGB PLUS Sync Compatible
- 
  - Smart Power Management integration for PSU/PC status monitoring and timely warning alert
- 
  - Amazon Alexa Supported
- 
  - Strict voltage regulation provides stable voltage
- 
  - 100% Japanese Capacitors (105°C /221 °F Ambient)
- 
  - Complete Hardware Protection (OCP, OVP, UVP, OPP, SCP, OTP)

## Structure

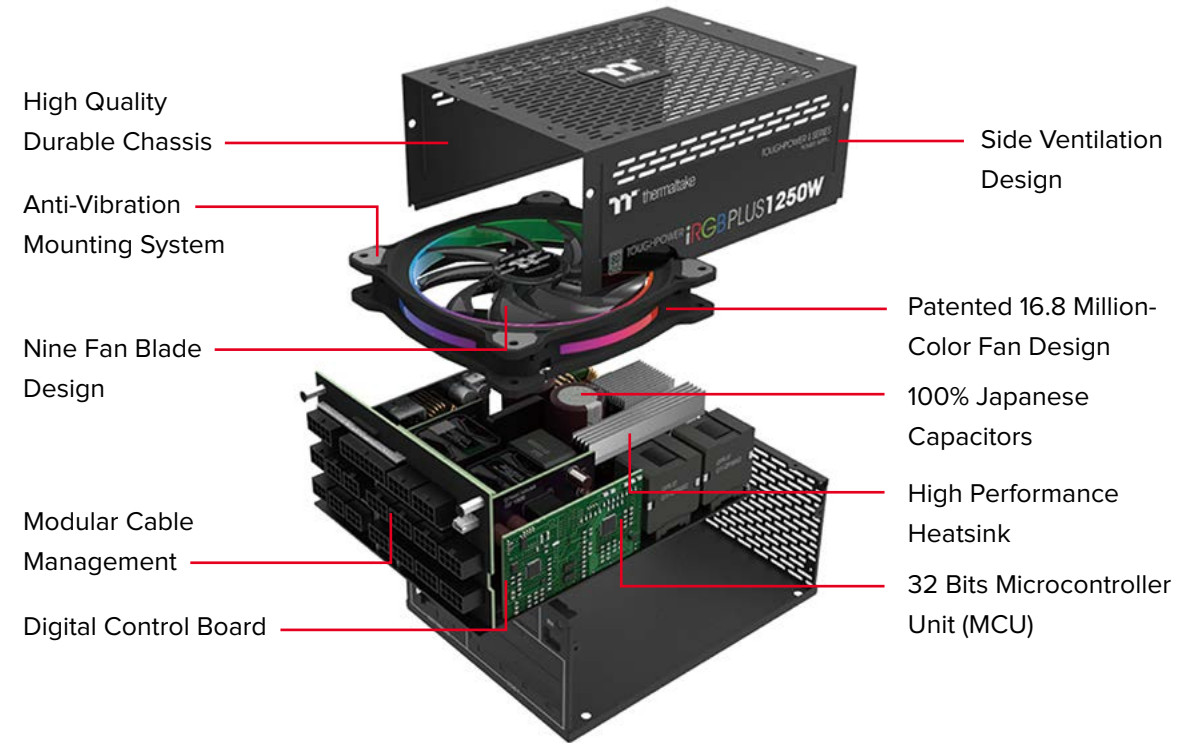

• Image is for reference only



## Patented 16.8 Million Colors Riing PLUS 14 RGB Fan

Featuring 12 addressable LEDs, great light coverage, uniform color and brightness. The built-in LED ring paints your build with 16.8 million colors.











## Toughpower iRGB PLUS Platinum Series

1200W/1050W/850W

Builds up with great quality and patented ultra-silent, 16.8 million-color RGB fan and 12 controllable single LEDs with 8 lighting modes, plus the support for three of intelligent platforms to help users monitor smart power supply units, and also becomes the world's first voice controllable digital power supply which can also be sync with all other Thermaltake TT RGB PLUS sync compatible products.

## Features

- 
 • Digitally controlled Riing PLUS RGB 16.8 million colors PSU fan with 8 lighting modes
- 
 • World's first voice controllable RGB fan
- 
 • TT RGB PLUS Sync Compatible
- 
 • Smart Power Management integration for PSU/PC status monitoring and timely warning alert
- 
 • Amazon Alexa Supported
- 
 • < 30mV Low Ripple, < ±2% Voltage Regulation, and >16ms Hold up time
- 
 • 100% Japanese Capacitors (105°C / 221 °F Ambient)
- 
 • Complete Hardware Protection (OCP, OVP, UVP, OPP, SCP, OTP)

## Structure

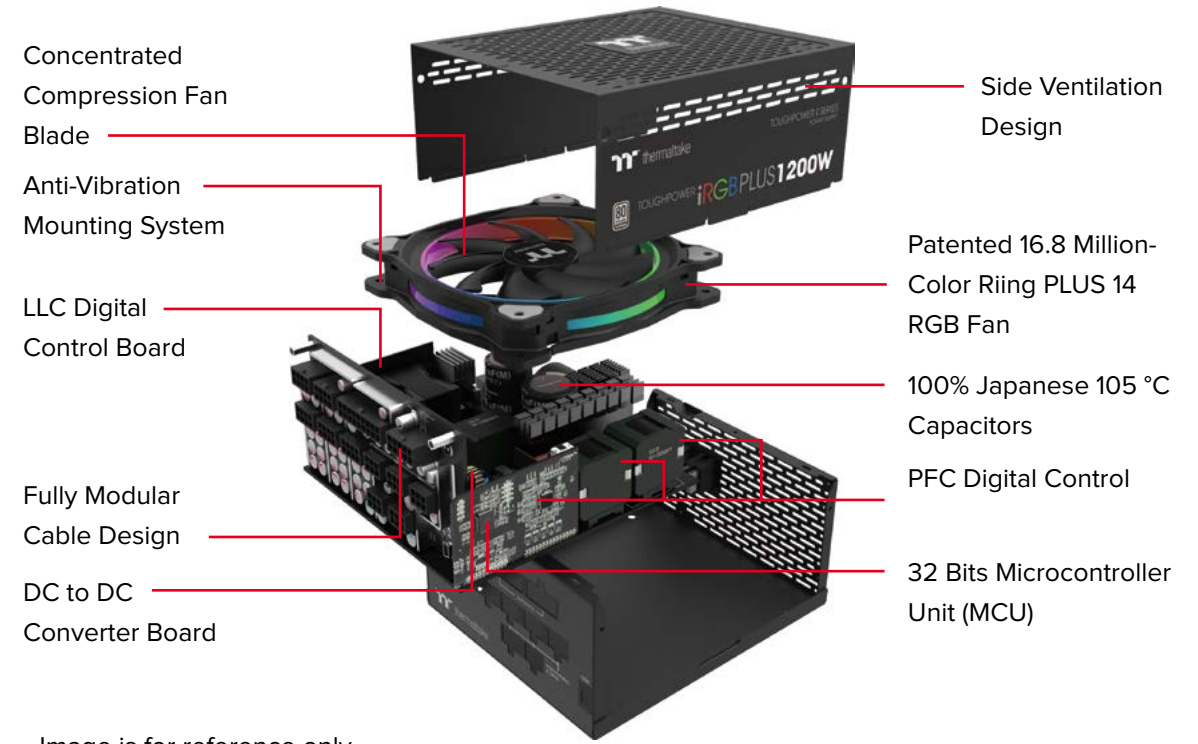

• Image is for reference only



## Patented 16.8 Million Colors Riing PLUS 14 RGB Fan

Featuring 12 addressable LEDs, great light coverage, uniform color and brightness. The built-in LED ring paints your build with 16.8 million colors.



## Toughpower iRGB PLUS Gold Series

1000W/850W/750W

Builds up with great quality and patented ultra-silent, 16.8 million-color Riing Duo 14 RGB Fan and 18 controllable single LEDs with 14 lighting modes, plus the support for three of intelligent platforms to help users monitor smart power supply units, and also becomes the world's first voice controllable digital power supply which can also be sync with all other Thermaltake TT RGB PLUS sync compatible products.

### Features



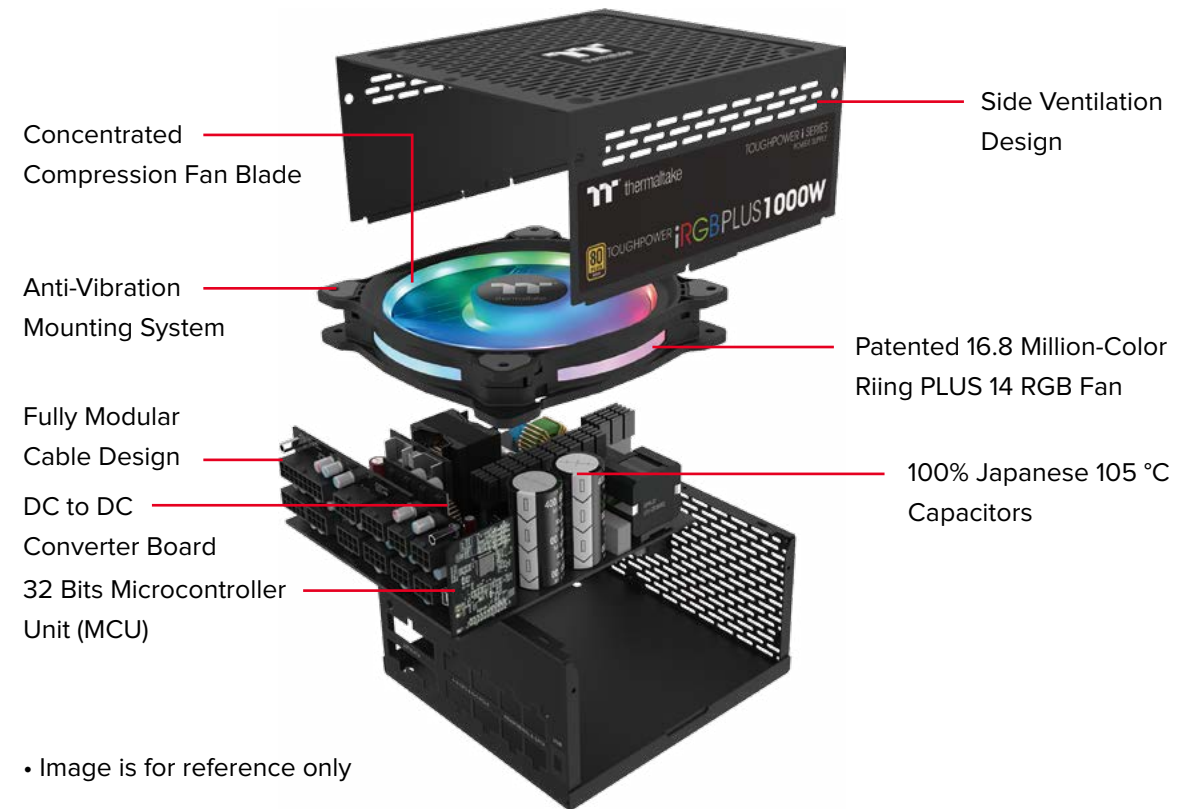

- 
• Digitally controlled Riing PLUS RGB 16.8 million colors PSU fan with 8 lighting modes
- 
• World's first voice controllable RGB fan
- 
• TT RGB PLUS Sync Compatible
- 
• Smart Power Management integration for PSU/PC status monitoring and timely warning alert
- 
• Amazon Alexa Supported
- 
• < 30mV Low Ripple, < ±2% Voltage Regulation, and >16ms Hold up time
- 
• 100% Japanese Capacitors (105°C / 221 °F Ambient)
- 
• Complete Hardware Protection (OCP, OVP, UVP, OPP, SCP, OTP)

### Structure



### Patented 16.8 Million Colors Riing PLUS 14 RGB Fan

One PSU, infinite possibilities! All starts from 18 addressable LEDs giving wide light, color and brightness coverage, and 2 LED rings bringing 16.8million-color illumination.

Items	Product											
	  <b>New</b>	 	 	 	 							
Hardware			Hardware									
Product Name	Toughpower iRGB PLUS Titanium		Toughpower iRGB Plus Titanium	Toughpower iRGB Plus Platinum		Toughpower iRGB Plus Gold			Toughpower DPS G RGB Titanium			
Wattage Range	1650W	1250W	1250W	1200W	1050W	850W	1000W	850W	750W	1500W	1000W	850W
80 +	Titanium		Titanium	Platinum		Gold			Titanium			
Cabling	Fully Modular		Fully Modular	Fully Modular		Fully Modular			Fully Modular			
RGB Lighting	Patentd 16.8 million colors RGB		16.8M Colors RGB Control	16.8M Colors RGB Control		16.8M Colors RGB Control			256 Colors RGB Control			
LED Lights Bulbs	18		12	12		18			2			
Fan	Patented Riing Duo 16.8 million colors RGB Hydraulic bearing fan		Patented Riing plus 14 RGB Fan with Hydraulic Bearing	Patented Riing plus 14 RGB Fan with Hydraulic Bearing		Patented Riing plus 14 RGB Fan with Hydraulic Bearing			Patented Riing 14 RGB Fan with Hydraulic Bearing			
Smart Zero Fan	Yes		Yes	Yes		Yes			Yes			
Operating Temperature	0° C ~ 50° C		0° C ~ 50° C	0° C ~ 50° C		0° C ~ 50° C			0° C ~ 50° C			
Ripple Noise Design	Less Than 30mV for Major Rails		Intel Requirement	Less Than 30 mV for Major Rails		Less Than 30 mV for Major Rails			Intel Requirement			
Voltage Regulation	±2% for Major Rails		Intel Requirement	±2% for Major Rails		±2% for Major Rails			Intel Requirement			
Warranty	10 Years		10 Years	10 Years		10 Years			10 Years			
Main Power Connector (20+4 pin)	1		1	1		1			1			
CPU (8pin)	1		1	1		1			1			
CPU (4+4pin)	1		1	1		1			1			
SATA (5Pin)	16		16	12	12	12	12	12	9	20	12	12
PCI-E (8pin)	8	12	4	-		-			4 4 3			
PCI-E (6+2pin)	12		4	8	8	6	8	6	4	6	4	3
Periphrral (4Pin)	1		8	8	4	4	4	4	4	12	8	4
Floppy (4Pin)	1		1	1		1			1			
USB	1		1	1		1			1			
Software			Software			Software			Software			
SPM	V		V	V		V			V			
TT RGB PLUS	V		V	V		V			-			
AI Voice Control	V		V	V		V			-			
Amazon Alexa	V		V	V		V			-			

More Information

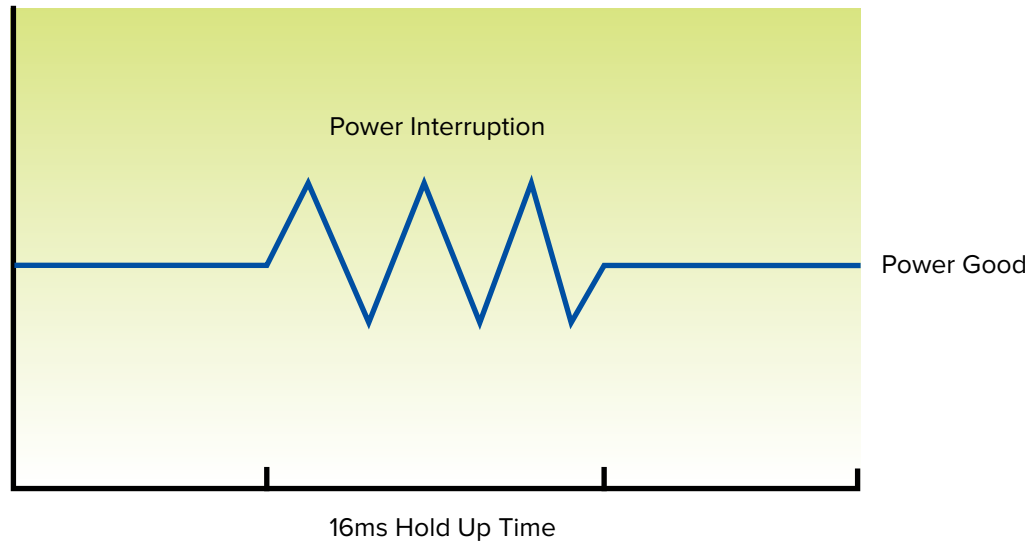

### >16ms and up Hold Up Time

During a power interruption, your computer might shut down or reboot. We make sure your PSU will deliver at least 16ms at 100% workload, without system reboot or resetting.

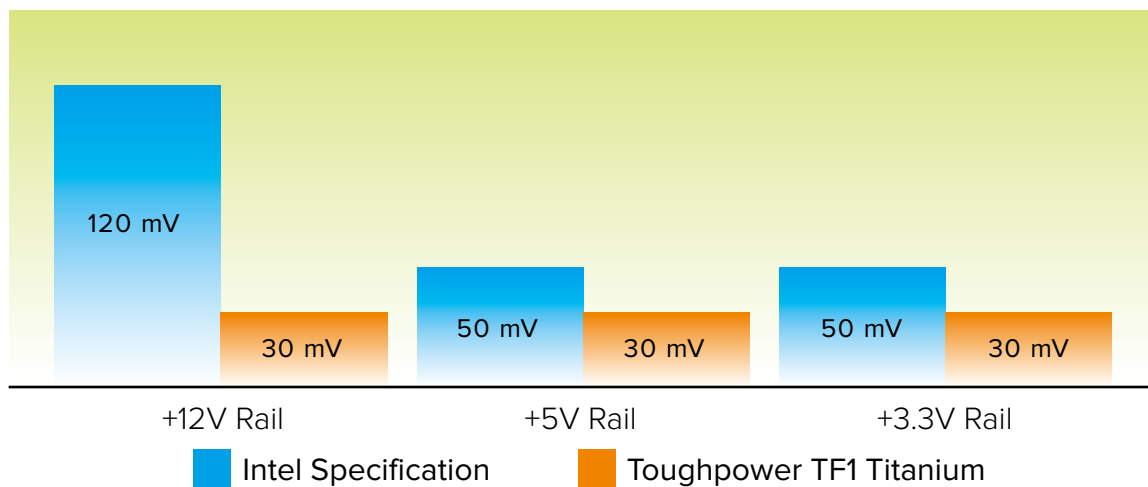

### <30mV Low Ripple Noise

From 0% to 100% load, ripples noise produced from 12V, 5V, or 3.3V are under 30mV for high stability and extend the lifetime on power supply.

Ripple noise could also means electricity waste and lower the better . The top quality components are used to ensure your computer system is protected.

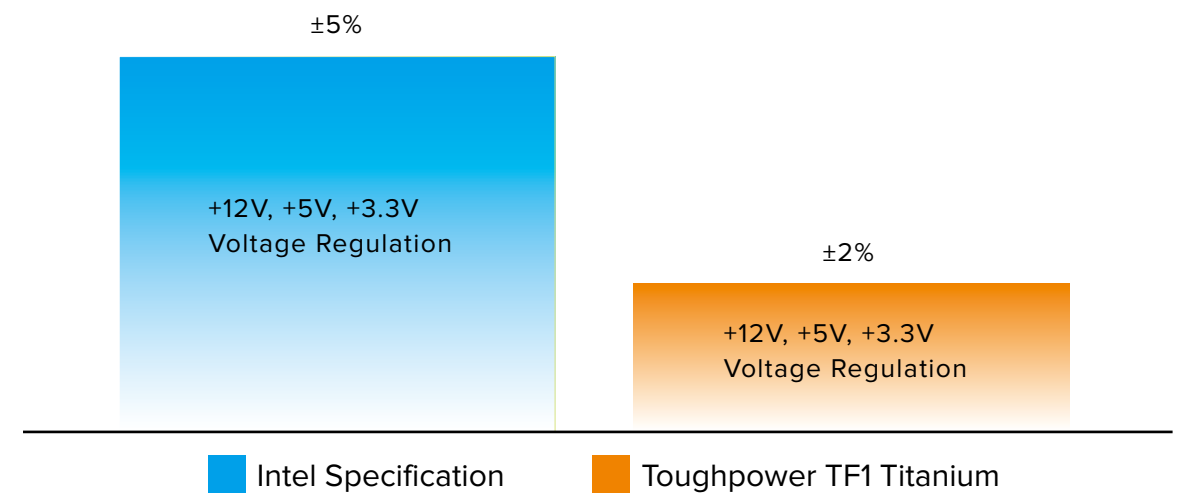

### Extremely Strict Voltage Regulation <±2%

We insist to provide no more than ±2% for major rails to meet highest performance. Even more strict than Intel's standard ±5% for major rails and ±10% for -12V.



### 100% Japanese Capacitors

100% high quality 105 °C (221 ° F) Japanese brand capacitors which greatly improve the durability and offer the highest stability and reliability.

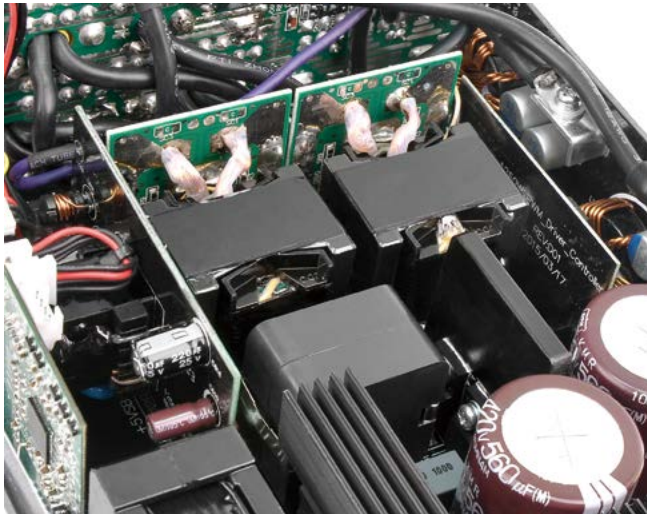

## High Amperage Single +12V Rail

Powerful single +12V rail ensures a stable and reliable supply to other PC components.

• Image is for reference only

AC Input	Input Voltage: 100V - 240V Input Current: 15A Frequency: 47Hz - 63Hz				
DC Output	+3.3V	+5V	+12V	-12V	+5VSB
Max Output Current	20A	20A	104A	0.3A	3A
Max Output Power	100W		1248W	3.6W	15W
Total Power	1250W				



## DC to DC for Stable Output Voltage

With DC to DC design, the unit can optimize maximum energy harvest for computer system. Such as efficiently change voltage level for 12V, 5V, and 3V and to match the loads to your power supply.

• Image is for reference only



## Smart Zero Fan

Smart Zero Fan ensures zero noise when the fan operates below 30% working load to minimize audible noise. The fan will operate when the power supply working load over 40%. A switch is provided for those who prefer the fan to spin constantly.

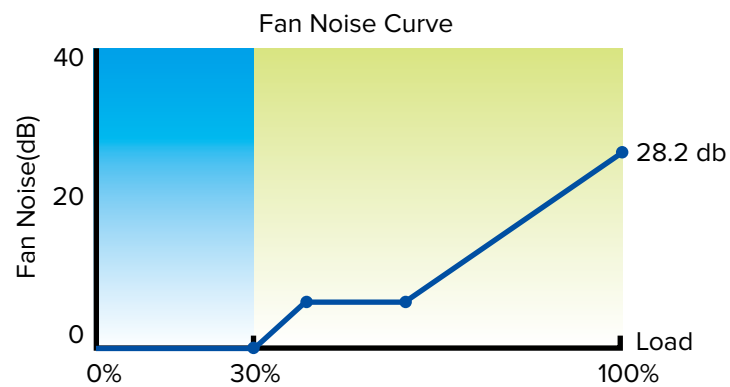

## Fully Modular Cable Design

Fully modular power supply offers cable selection for users while powering the system at an advantageous voltage. Flat cable makes cable management easier, reduces clutter and increases airflow inside the chassis.





### 80 PLUS Titanium Certified

Saves energy through its high energy efficiency up to 94% and is certified to 80 PLUS® Titanium.



### 80 PLUS Gold Certified

Saves energy through its high energy efficiency up to 90% and is certified to 80 PLUS® Gold.



### 80 PLUS Platinum Certified

Saves energy through its high energy efficiency up to 92% and is certified to 80 PLUS® Platinum.



### 80 PLUS Bronze Certified and Intel C6/C7 States Ready

Saves energy through its high energy efficiency up to 85%. It has been optimized to work with all generations of Intel's processors to achieve maximum energy savings.

## Cybenetics EFFICIENCY LEVELS (115V/230V)



EFFICIENCY LEVELS (115V INPUT)	EFFICIENCY (1) (2)	PF (3)	5VSB EFFICIENCY (1) (3) (4)	VAMPIRE POWER (3)
<b>TITANIUM</b>	≥91% & <93% overall efficiency	≥0.980	>77%	<0.13W
<b>PLATINUM</b>	≥89% & <91% overall efficiency	≥0.975	>76%	<0.16W
<b>GOLD</b>	≥87% & <89% overall efficiency	≥0.970	>75%	<0.19W



EFFICIENCY LEVELS (230V INPUT)	EFFICIENCY (1) (2)	PF (3)	5VSB EFFICIENCY (1) (3) (4)	VAMPIRE POWER (3)
<b>TITANIUM</b>	≥93% & <95% overall efficiency	≥0.940	>76%	<0.15W
<b>PLATINUM</b>	≥91% & <93% overall efficiency	≥0.935	>75%	<0.18W
<b>GOLD</b>	≥89% & <91% overall efficiency	≥0.930	>74%	<0.20W

## Cybenetics NOISE LEVELS (115V/230V)



NOISE LEVELS (115V/230V INPUT)	NOISE REQUIREMENTS (1)
<b>A+</b>	≥15 dB(A) & <20 dB(A)
<b>A</b>	≥20 dB(A) & <25 dB(A)
<b>A-</b>	≥25 dB(A) & <30 dB(A)
<b>STANDARD ++</b>	≥30 dB(A) & <35 dB(A)
<b>STANDARD +</b>	≥35 dB(A) & <40 dB(A)



# Digitally Master Your Power Supply Through Smart Power Management

Seamlessly integrates three intelligent platforms, DPS G PC APP, DPS G Smart Power Management, and DPS G Mobile APP, to compile key statistics about your PC into detailed charts and breakdowns for your PC management. With easy access to SPM via PC or mobile devices, you can have full control of your build anytime and anywhere.



PC APP



Mobile APP



Cloud

## Smart Power Management (SPM)

Comes in the spirit of optimizing the system performance, encouraging flexibility and saving energy to cover all these user-oriented issues:

### PSU Status Monitoring

PC APP displays real-time key parameters of PSU consumption. Mobile APP and Cloud system collect historical data in easy-to-read charts for your review.



### PC Status Monitoring

Via PC APP users see real-time status of CPU/RAM/multiple VGA graphics cards. For historical data, our Mobile APP and Cloud system have them all covered!



### Intuitive RGB Lighting Control

Either on PC APP or Mobile APP, an intuitive RGB lighting control dashboard awaits! Users can even verbally command lighting modes via AI Voice Control on Mobile APP.



## PC APP includes 4 fan modes

PC APP includes 4 fan modes: Silent, Performance, Zero Fan, and Customize. "Silent" slows down fan speed to lower noise; "Performance" speeds up the fan to optimize thermal performance; "Zero Fan" starts up the fan on a specific percent of loading so as to minimize PC audible noises; "Customize" allows you to customize the RPM of the fan.



## Malfunction Warning Alert

Real-time warning alert appears on PC APP, Mobile APP and also your email inbox when fan failure, PSU over temperature (over 140°F/60°C), or abnormal voltage level (over/under 5% of normal level) occurs. Then users can shut down their PC remotely to avoid further damage.



## PC Off Remote Control

Mobile APP and Cloud enable users to turn off the PC remotely when they receive the warning message or when they schedule PC to shutdown at any time they want, all through their PC/mobile device.



## AI Voice Control RGB Fan

Talking to DPS G Mobile App is an easier, faster way to set lights for RGB fan of your power supply. You can ask it to turn the lights on or off, switch lights modes, dim the lights, change light colors, or adjust lights speeds.



## TT RGB PLUS Supported



Our patented intelligent lighting software, TT RGB PLUS, allows for addressable LEDs lighting control. Sync your digital PSU colors seamlessly with all other TT RGB PLUS-supported products!



## Amazon Alexa and Razer Chroma Supported

All Thermaltake TT RGB PLUS products are able to work with Amazon Alexa Voice Service and Razer Chroma ecosystem. The former allows users to control lights by talking to Alexa-enabled device. Also, users can install both TT RGB PLUS and Razer Chroma to experience synchronized gaming RGB lighting effects on their power supply unit and PC build!

## See what each platform has got you covered

 DPS G PC App	 DPS G Mobile App	 Cloud Management
TT RGB PLUS & Amazon Alexa	TT RGB PLUS & AI Voice Control	Energy Consumption/ ECO Report
RGB LED control	RGB LED control	PC OFF remote control
Real-time PSU/PC status monitoring	PSU/PC status reviewing	Malfunction warning alert
Smart Fan Modes	PC OFF Remote control	-
Malfunction warning alert	Malfunction warning alert	-



## **Asia**

### **Taiwan Headquarters - Thermaltake Technology Co., Ltd.**

5F, No. 185, Sec.2, Tiding Blvd., Neihu Dist.,

Taipei City 114, Taiwan

TEL: +886-2-8797-5788

FAX: +886-2-8797-8055

E-MAIL: [info@thermaltake.com](mailto:info@thermaltake.com)

WEBSITE: <http://www.thermaltake.com>

### **Thermaltake Capital Beijing Co., Ltd.**

#907, HaiTai Plaza, No. 229, North 4th Ring Road,

Haidian District, Beijing, 100083, PRC

TEL: +86-10-8288-3159

FAX: +86-10-8288-3302

E-MAIL: [ttchina@thermaltake.com.cn](mailto:ttchina@thermaltake.com.cn)

WEBSITE: <http://www.thermaltake.com.cn>

## **Americas**

### **Thermaltake USA Inc.**

20420 Business Parkway, City of Industry, CA, 91789 USA

TEL: +1626-968-9189

SUPPORT: +1800-988-1088

FAX: +1626-968-7659

E-MAIL: [sales@thermaltakeusa.com](mailto:sales@thermaltakeusa.com)

WEBSITE: <http://www.thermaltakeusa.com>

## **Australia**

### **Thermaltake Australia and New Zealand Pty Ltd.**

63-69 Ricketts Road Mount Waverley VIC 3149 Australia

TEL: +613 9131 9827

E-MAIL: [sales@thermaltake.com.au](mailto:sales@thermaltake.com.au)

WEBSITE: <http://www.thermaltake.com.au>

## **Europe**

### **Thermaltake Germany GmbH**

Oststraße 1C, 22844 Norderstedt, Germany

TEL: +49(0)40/30-85-86-0

FAX: +49(0)40/30-85-86-89

E-MAIL: [info@thermaltake.de](mailto:info@thermaltake.de)

WEBSITE: <http://de.thermaltake.com>

### **Thermaltake Russia Representative Office**

Office 404, bld. 40/22, Nikoloyamskaya Str.,

Moscow 109004, Russia

TEL: +7(916) 726- 2888

E-MAIL: [info@thermaltakerussia.ru](mailto:info@thermaltakerussia.ru)

WEBSITE: <http://ru.thermaltake.com>